

Tools

F45

FT

FS

FL

F65

FM

F85

FH

FK

FB140

FB175

FB295

SPIRAL

FW

FLX

FMX

FHX

FBX175

FBX295

ACC

CA

PAL

FC

TOOL

IDX

Contents

Pin insertion tool 3

Rivet crimping pliers 3

Mounting tool 4

Rivet crimping clamp 4

Drill fixture 4



Washer cleaner 4

Bending Machine 4

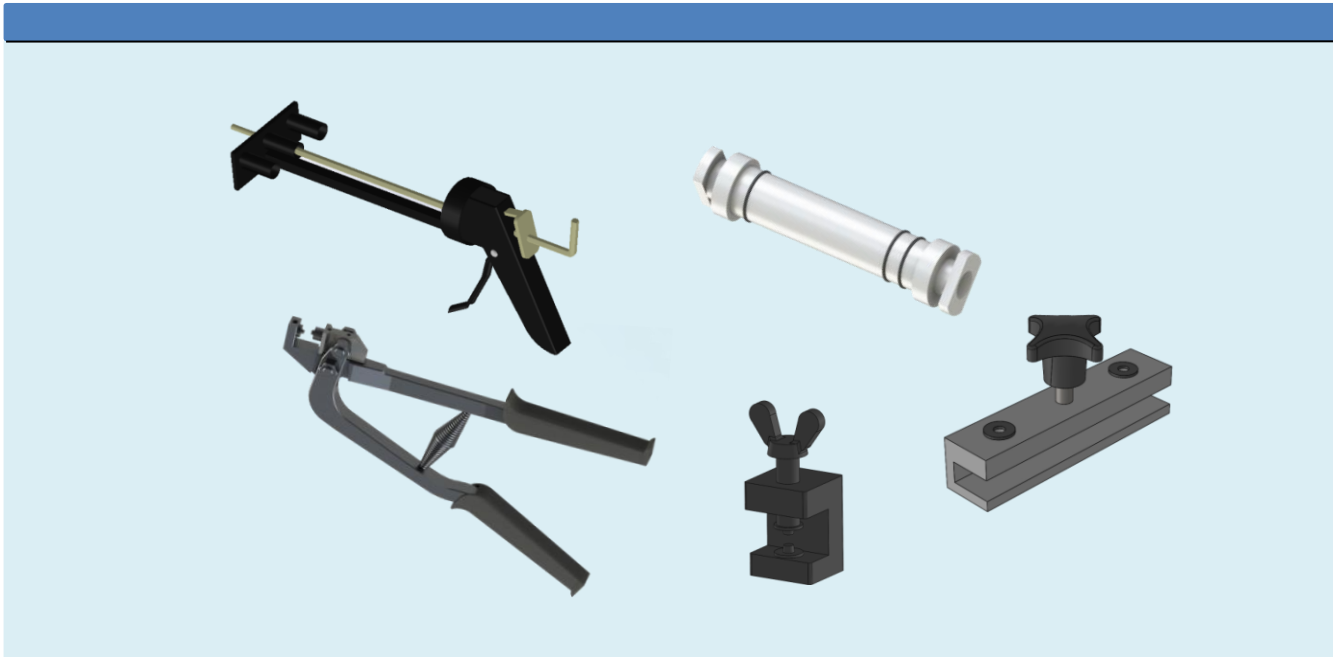
Tools

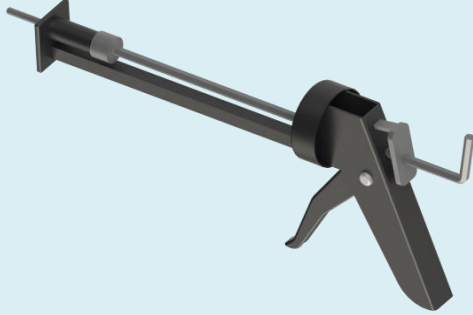

Tools

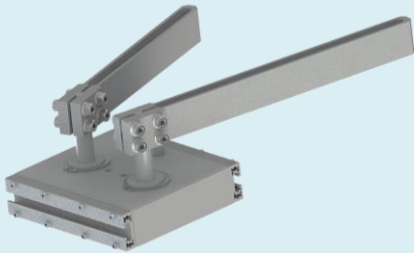
| | | |
|---|--|---|
| <p>Pin insertion tool</p> <p>FLMJ 4 For FS, FL FMMJ 6 For FM FHMJ 6 For FH</p> |  | <p>F45</p> <p>FT</p> <p>FS</p> <p>FL</p> <p>F65</p> <p>FM</p> |
| <p>Pin insertion tool</p> <p>FKMJ 8 For FK FBMJ 6 For FB 140, 175, 295</p> |  | <p>F85</p> <p>FH</p> <p>FK</p> <p>FB140</p> <p>FB175</p> |
| <p>Pin insertion tool</p> <p>FBMJ 6 P For FM, FH, F85, FB140</p> |  | <p>FB295</p> <p>SPIRAL</p> <p>FW</p> <p>FLX</p> <p>FMX</p> <p>FHX</p> |
| <p>Rivet crimping pliers</p> <p>F5051395 For FL, FM, FH F3924776 For FS F3923563 For F45</p> |  | <p>FBX175</p> <p>FBX295</p> <p>ACC</p> <p>CA</p> <p>PAL</p> |
| <p>Traffic police man</p> |  | <p>FC</p> <p>TOOL</p> <p>IDX</p> |

Tools

Mounting tool

| | |
|-----------------|----------------------|
| FLMR 140 | For FS & FL |
| FMMR 140 | For FM & FB140 |
| FHMR 200 | For FH |
| FKMR 200 | For FK |
| FBMR 170 | For F85, FB175 & 295 |

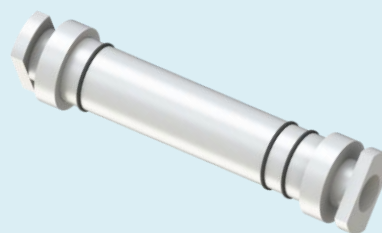

Rivet crimping clamp

| | |
|-----------------|----------------|
| F3923005 | For FL, FM, FH |
| F3924770 | For FS |

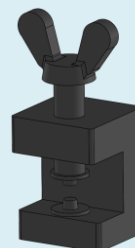

Drill fixture

| | |
|-----------------|----------------|
| F3924774 | For FS |
| F3920500 | For FL, FM, FH |

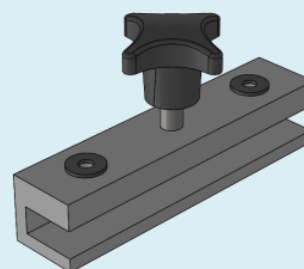

| | |
|-----------------|---------|
| F3923584 | For F45 |
|-----------------|---------|

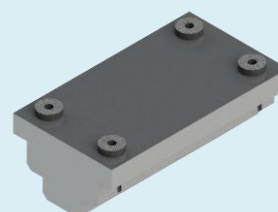

Washer cleaner



Tools

Bending Machine

F3922963



Drill fixture

F5116761 For F65

For the connection bracket hole pattern

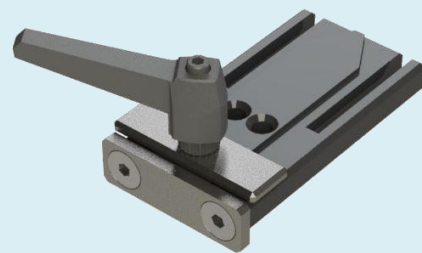

Mounting tool for slide rail

FWMR 135



F45

FT

FS

FL

F65

FM

F85

FH

FK

FB140

FB175

FB295

SPIRAL

FW

FLX

FMX

FHX

FBX175

FBX295

ACC

CA

PAL

FC

TOOL

IDX

Tools
